

Barter Theatre
Main Stage

Barter Players
2014 Holiday Show

Jingle All the Way

Drawing Date: 10.19.2014

Revision Date: 10.28.2014

Plot Date: n/a

Director: John Hardy

Tech Director: Caspar Eichin

Dwg By: HMB

Designer: Holly M Breuer

Drawing: Groundplan

Plate Scale: 3/8" = 1'-0"

Plate
1 of 7

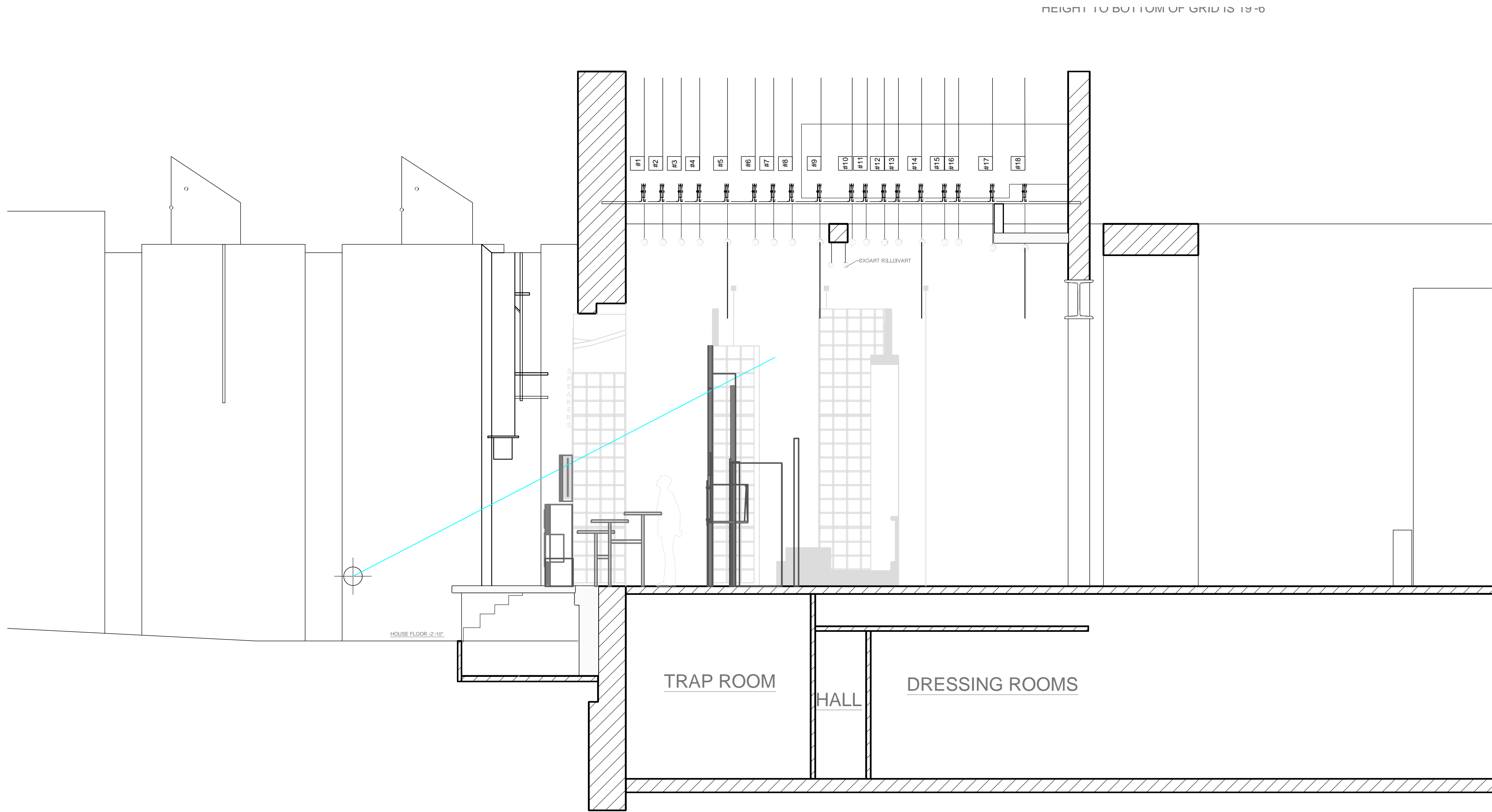

Barter Theatre
Main Stage

Barter Players
2014 Holiday Show

Jingle All the Way

Drawing Date: 10.19.2014

Revision Date: 10.28.2014

Plot Date: n/a

Director: John Hardy

Tech Director: Caspar Eichin

Dwg By: HMB

Designer: Holly M Breuer

Drawing: Section - To SR

Plate Scale: 1/4" = 1'-0"

Plate
2 of 7

MAX HEIGHT A PIPE CAN FLY OUT IS 19'-4" TO BOTTOM OF PIPE
HEIGHT TO BOTTOM OF GRID IS 19'-6"

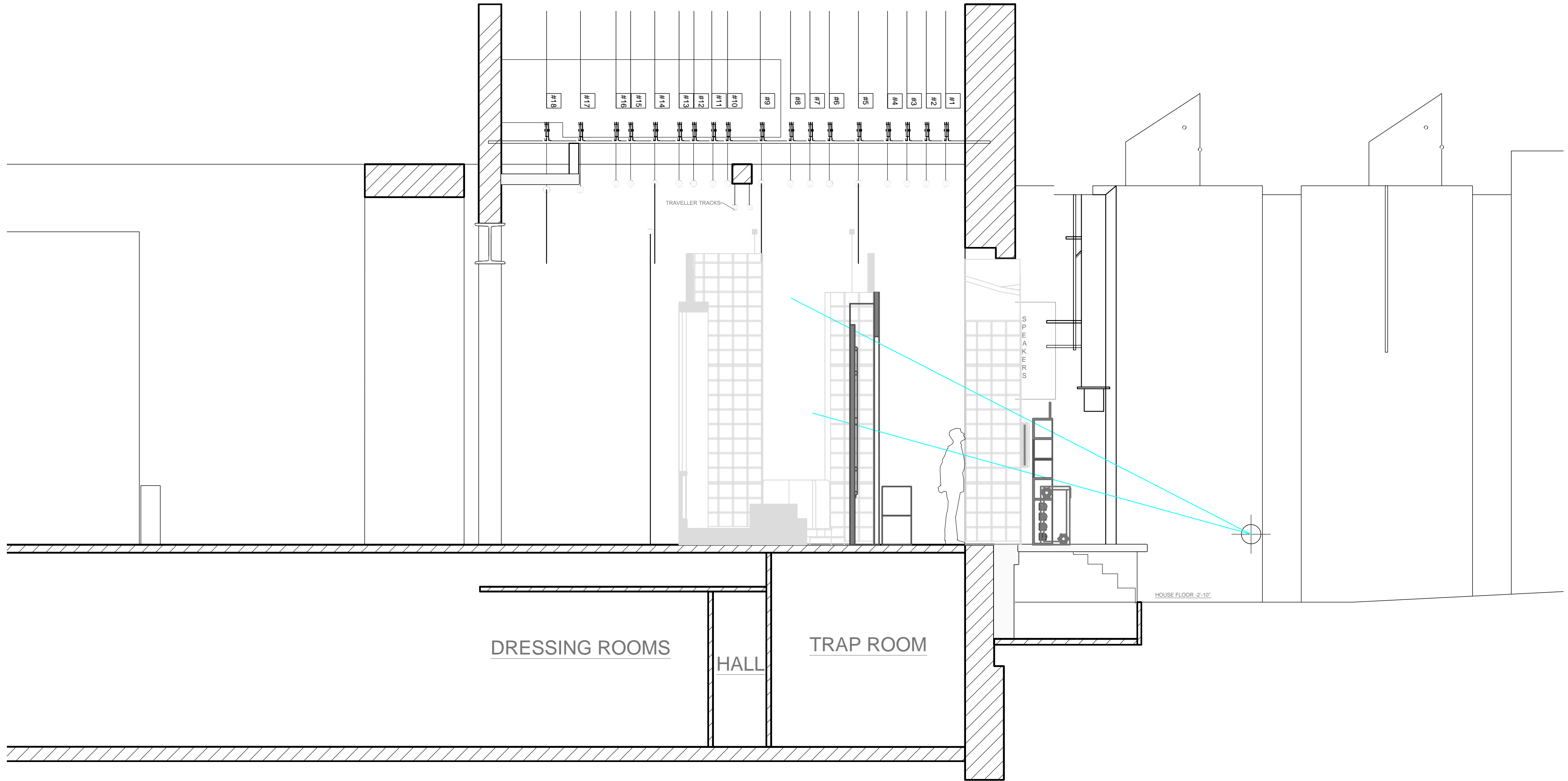

Barter Theatre
Main Stage

Barter Players
2014 Holiday Show

Jingle All the Way

Drawing Date: 10.19.2014

Revision Date: 10.28.2014

Plot Date: n/a

Director: John Hardy

Tech Director: Caspar Eichin

Dwg By: HMB

Designer: Holly M Breuer

Drawing: Section - To SL

Plate Scale: 1/4" = 1'-0"

Plate
2a of 7

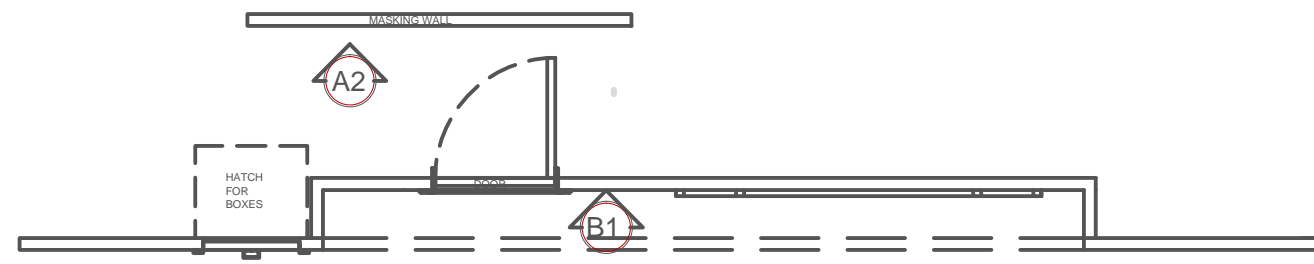

A1 UPSTAGE MAIN WALL:
PLAN VIEW

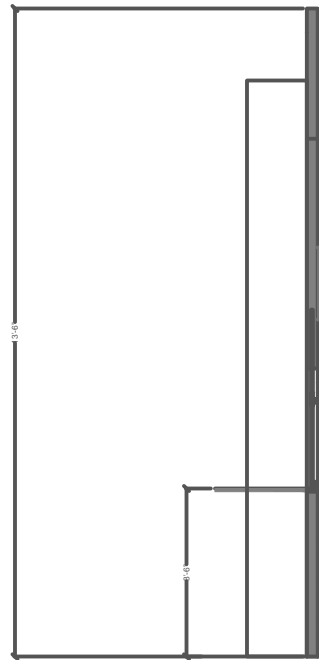

A3 MAIN WALL: RIGHT SECTION

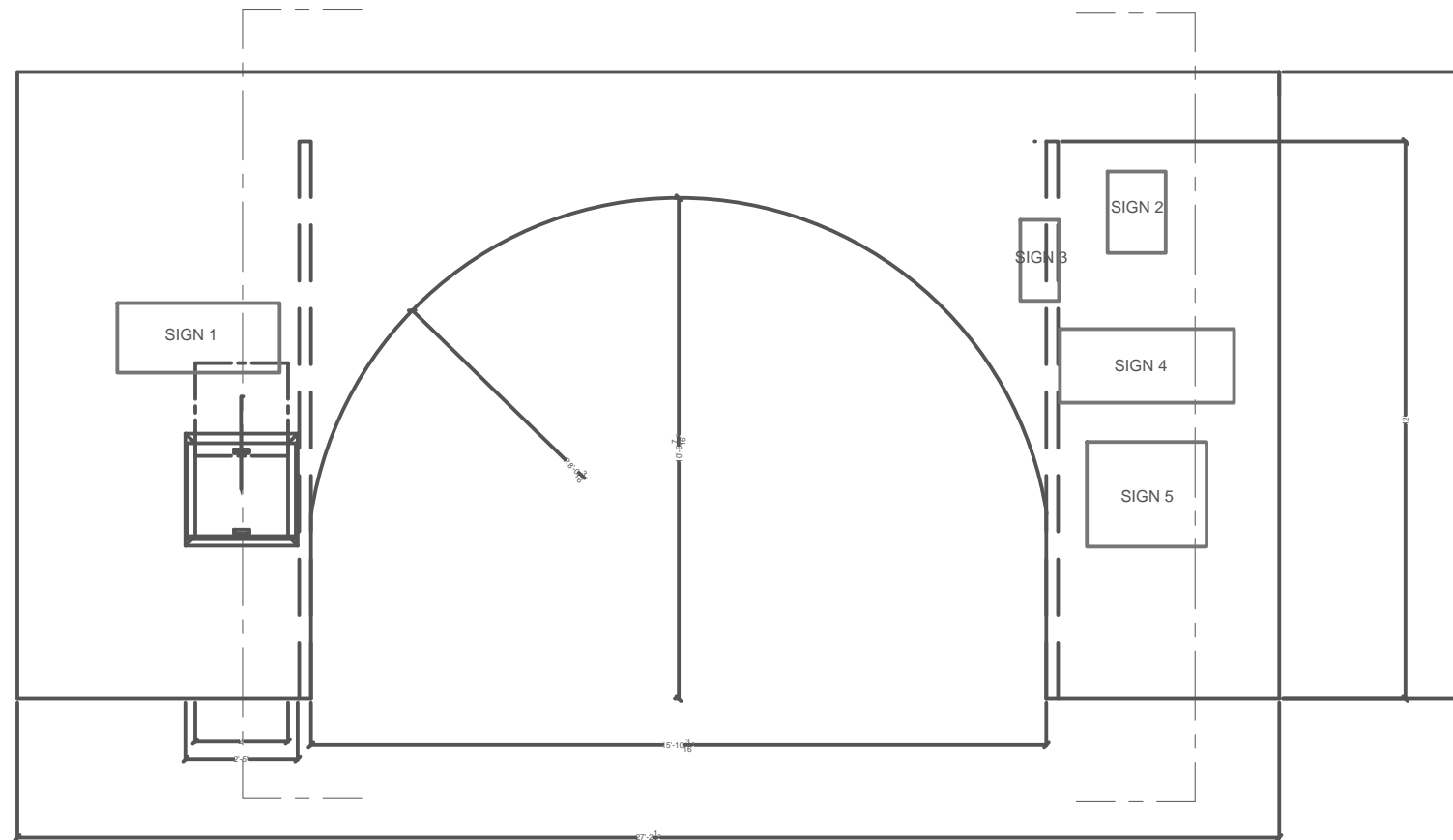

A4 MAIN WALL: FRONT VIEW

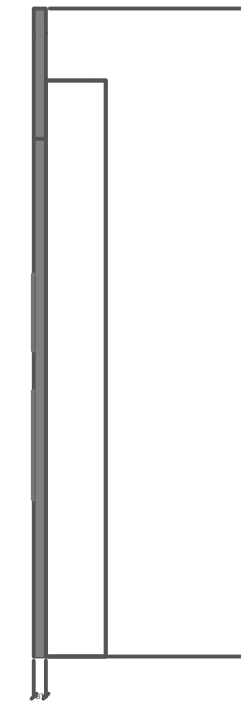

A5 MAIN WALL: LEFT SECTION

NOTE:

1. HATCH IN RIGHT SIDE OF WALL IS FUNCTIONAL AND SHOULD SLIDE UP TO ALLOW FOR PACKAGES TO BE PUT THROUGH THE OPENING.
2. SIGNS TO BE CREATED BY PROPS?



A2-2 MASKING WALL: PLAN VIEW

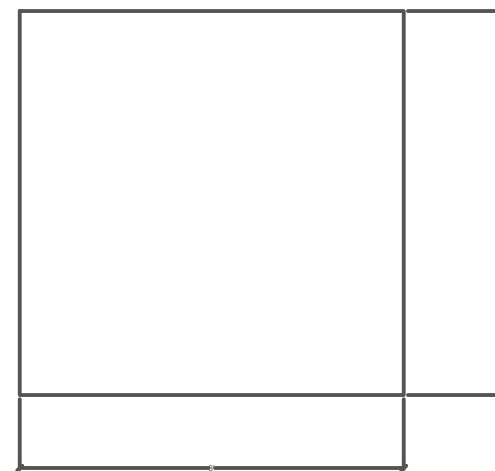

A2 MAIN WALL: MASKING WALL

SIGN LIST:

1. "RECEIVING DEPARTMENT"
2. "STACK CAREFULLY"
3. "DO NOT CLIMB ON SHELVING"
4. "GIFT WRAP DEPARTMENT"
5. CORK BOARD WITH PAPER DRESSING

Barter Theatre Main Stage
Barter Players 2014 Holiday Show
Jingle All the Way
Drawing Date: 10.19.2014 Revision Date: 10.28.2014 Plot Date: n/a
Director: John Hardy Tech Director: Caspar Eichen
Dwg By: HMB Designer: Holly M Breuer
Drawing: US Main Wall Plate Scale: 1/4" = 1'-0"
Plate # 3 of 7

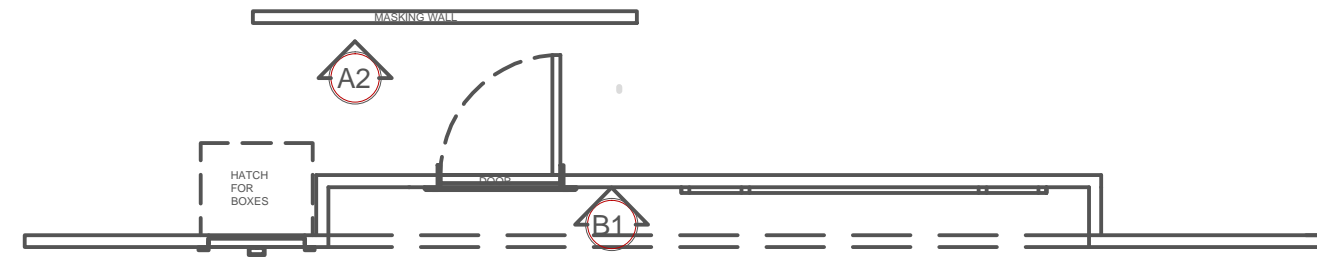

A1 UPSTAGE MAIN WALL:
PLAN VIEW

SIGN LIST:
6. "PALLET STORAGE AREA"

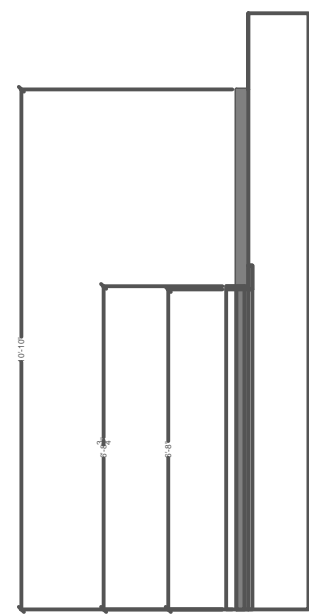

B2 DOOR/WINDOW WALL:
RIGHT SECTION

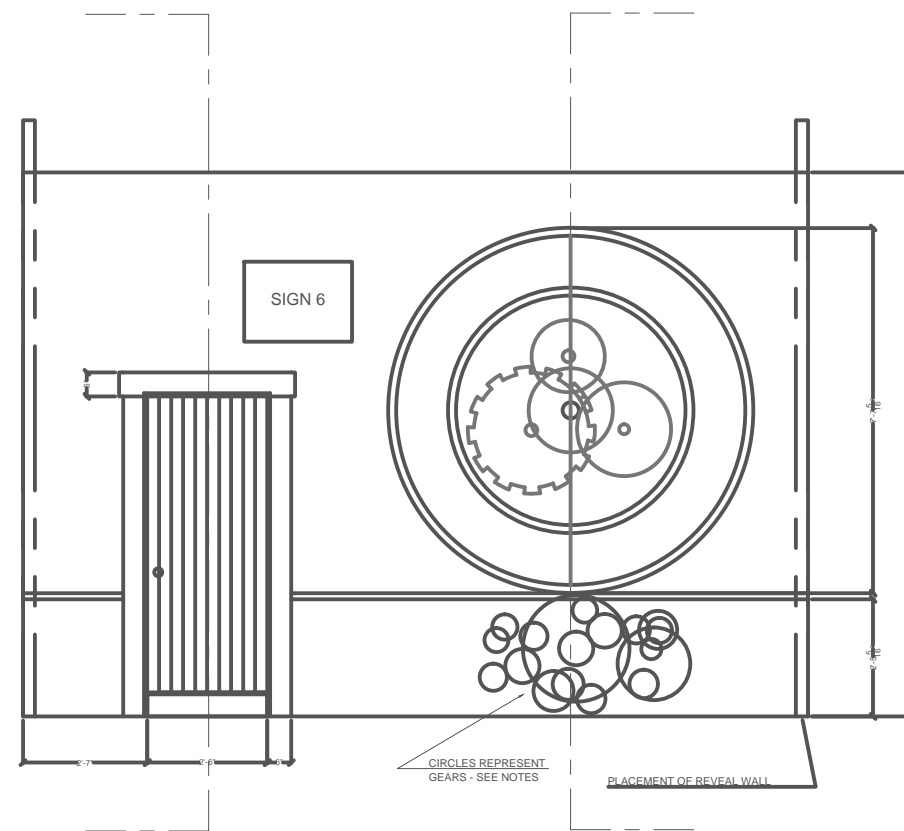

B1 DOOR/WINDOW WALL:
FRONT VIEW

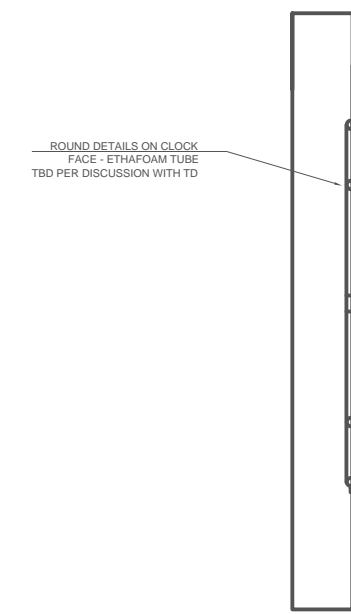

B3 DOOR/WINDOW WALL:
LEFT SECTION

NOTE:

1. DOOR IS FUNCTIONAL. MAY BE STOCK DOOR AS LONG AS IT IS NOT A STANDARD MODERN INTERIOR DOOR.
2. GEARS AT CENTER OF CLOCK RIGGED TO "SHAKE" AND POSSIBLY SPIN; TO BE MANIPULATED BY ACTORS UPSTAGE OF WALL - DISCUSS WITH DESIGNER.
3. GEARS INSTALLED ON WALL BELOW CLOCK SHOULD HAVE PARTS THAT CAN BE REMOVED AND MANIPULATED BY ACTORS - MAY BE INSTALLED BY PROPS - DISCUSS WITH DESIGNER.
4. WILL NEED SOME SORT OF HOLE OR ACCESS POINT FROM WITHIN CLOCK FACE TO ALLOW "DUST" TO ENTER THE PLAYING SPACE.

Barter Theatre
Main Stage
Barter Players
2014 Holiday Show

Jingle All the Way

Drawing Date: 10.19.2014
Revision Date: 10.28.2014
Plot Date: n/a

Director: John Hardy

Tech Director: Caspar Eichen

Dwg By: HMB

Designer: Holly M Breuer

Drawing: US Door Wall

Plate Scale: 1/4" = 1'-0"

Plate
4 of 7

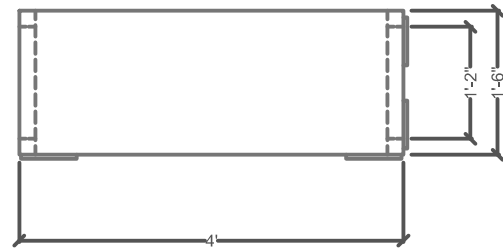

C1 GIFT WRAP COUNTER:
PLAN VIEW

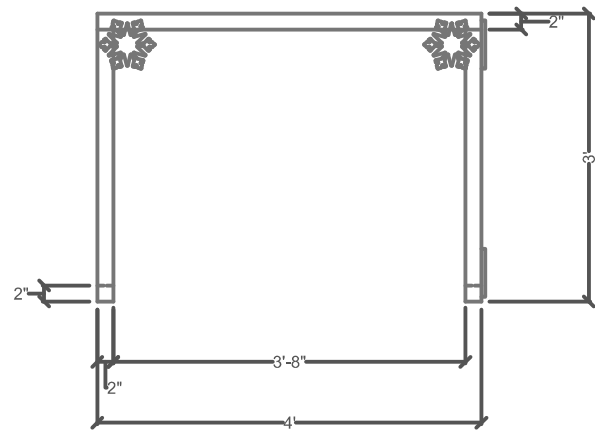

C2 GIFT WRAP COUNTER:
FRONT VIEW

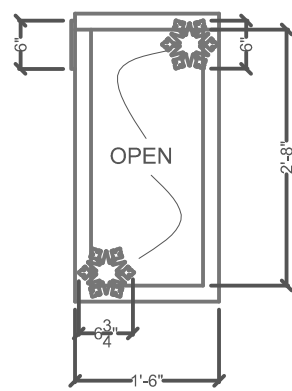

C3 GIFT WRAP COUNTER:
SIDE VIEW

NOTE:

1.DISCUSS BASE & HOW TO SECURE TO THE DECK WITH DESIGNER.

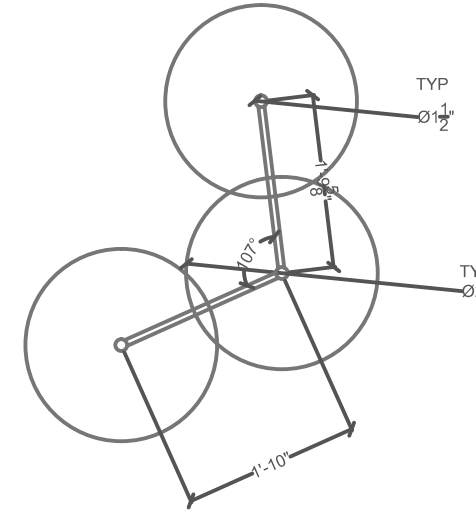

D1 RECEIVING TABLE:
PLAN VIEW

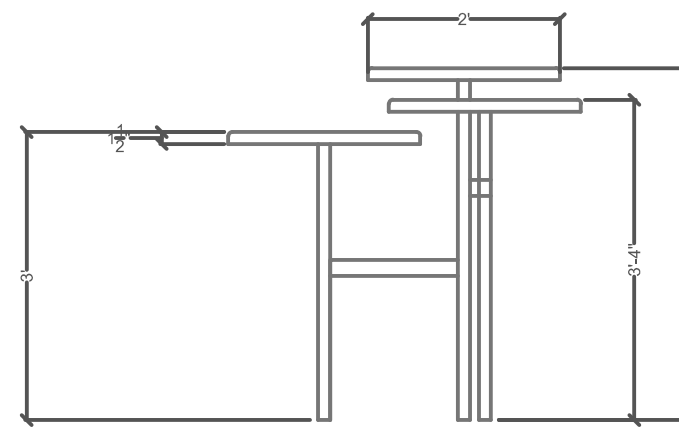

D2 RECEIVING TABLE:
FRONT VIEW

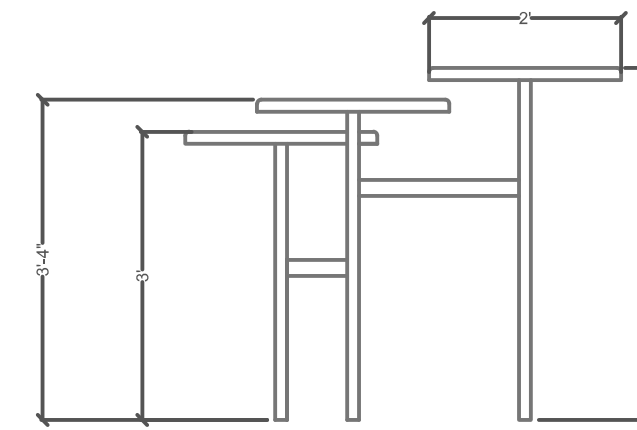

D3 RECEIVING TABLE:
SIDE VIEW

Barter Theatre
Main Stage
Barter Players
2014 Holiday Show

Jingle All the Way

Drawing Date: 10.19.2014
Revision Date: 10.28.2014
Plot Date: n/a

Director: John Hardy

Tech Director: Caspar Eichen

Dwg By: HMB

Designer: Holly M Breuer

Drawing: Tables

Plate Scale: 1/2" = 1'-0"

Plate
5 of 7

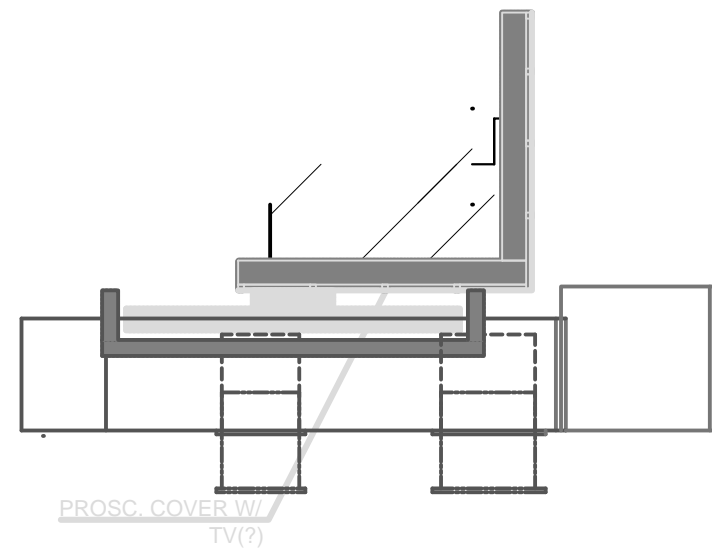

E1 FILING CABINET:
PLAN VIEW

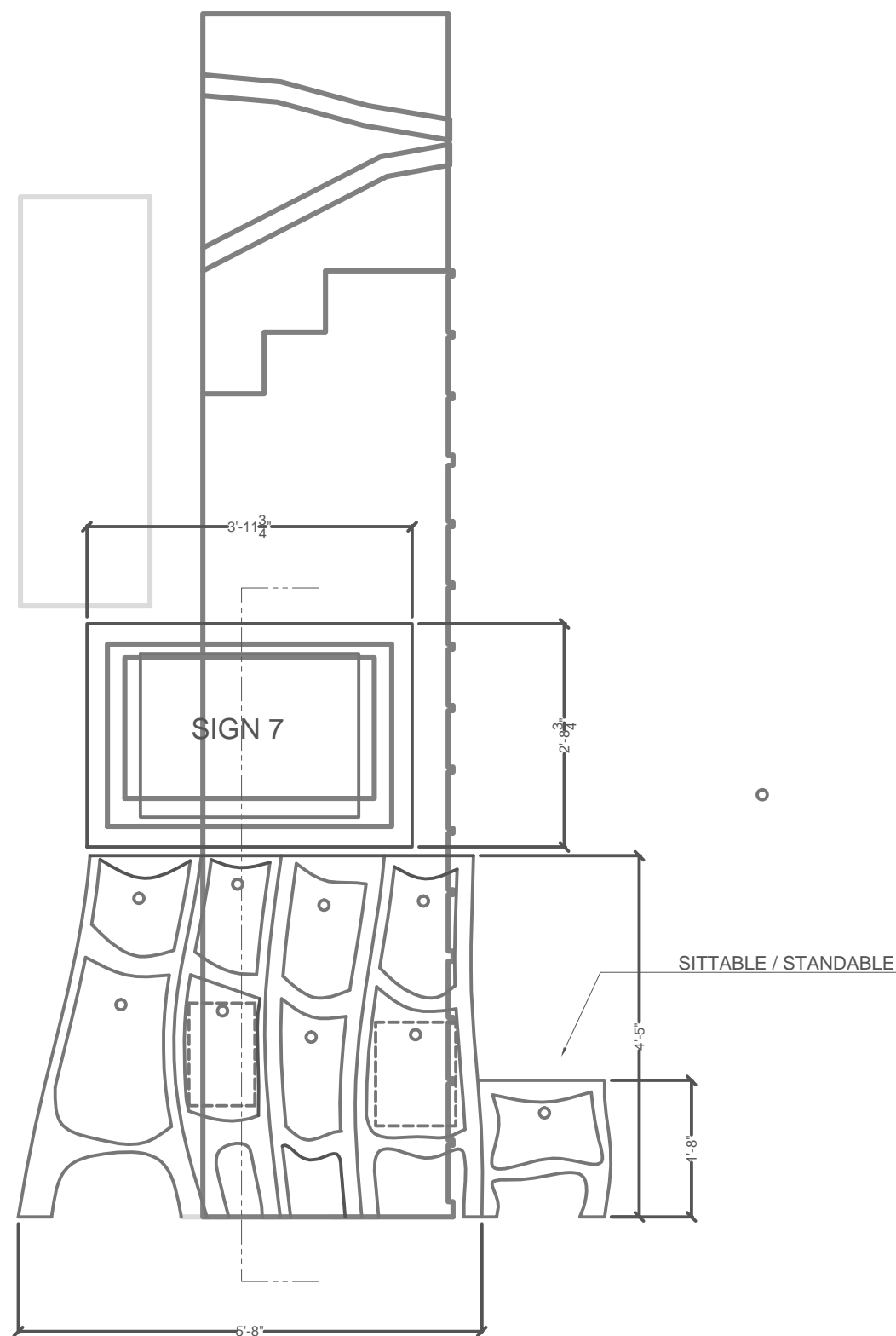

E2 FILING CABINET:
FRONT VIEW

NOTE:

1. ALL DRAWERS EXCEPT (2) INDICATED ARE FAUX - FRONT OF DRAWER SITS $\frac{1}{2}$ " OUT FROM SURFACE OF CABINET & EACH DRAWER HAS HANDLE.
2. (2) PRACTICAL DRAWERS, AS INDICATED.
3. SIZE & CONSTRUCTION OF BOX AROUND TV TBD PENDING MOUNTING METHOD FOR "CHRISTMAS CAROL" TV.

SIGN LIST:

7. "NOTICE: ALL TRUCK DRIVERS MUST WAIT IN DESIGNATED AREA"

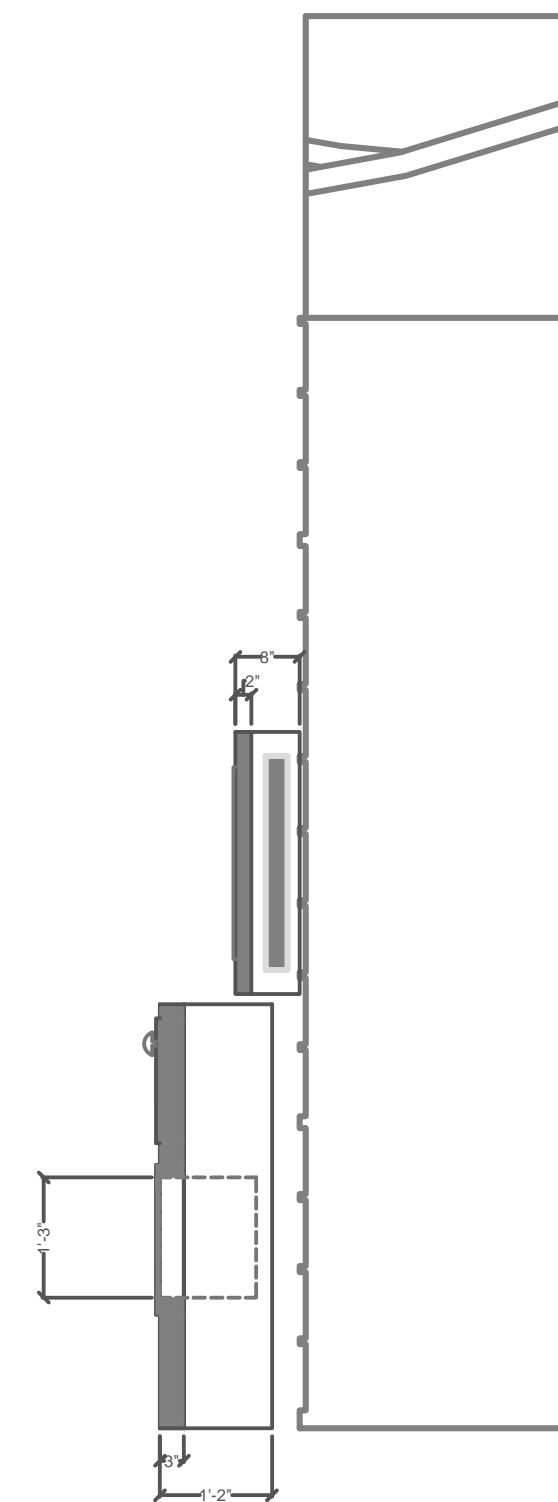

E3 FILING CABINET:
SECTION

Barter Theatre Main Stage
Barter Players 2014 Holiday Show
<i>Jingle All the Way</i>
Drawing Date: 10.19.2014
Revision Date: 10.28.2014
Plot Date: n/a
Director: John Hardy
Tech Director: Caspar Eichen
Dwg By: HMB
Designer: Holly M Breuer
Drawing: Filing Cabinets
Plate Scale: 1/2" = 1'-0"
Plate # 6 of 7

NOTE:

1. SHELF TO BE PULLED FROM STOCK AND MODIFIED TO BE SIMILAR TO SPEC'D UNIT. MUST BE WIDE AND TALL ENOUGH TO MASK TELEVISION FROM "MODERN CHRISTMAS CAROL."

2. ROLLS AT BOTTOM ARE WRAPPING PAPER - ONLY (1) IS PRACTICAL. WILL BE DRESSED BY PROPS.

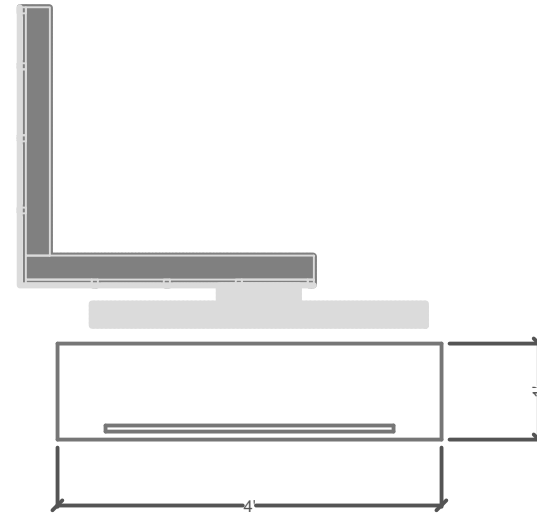

F1 SL PRO GIFT WRAP SHELF:
PLAN VIEW

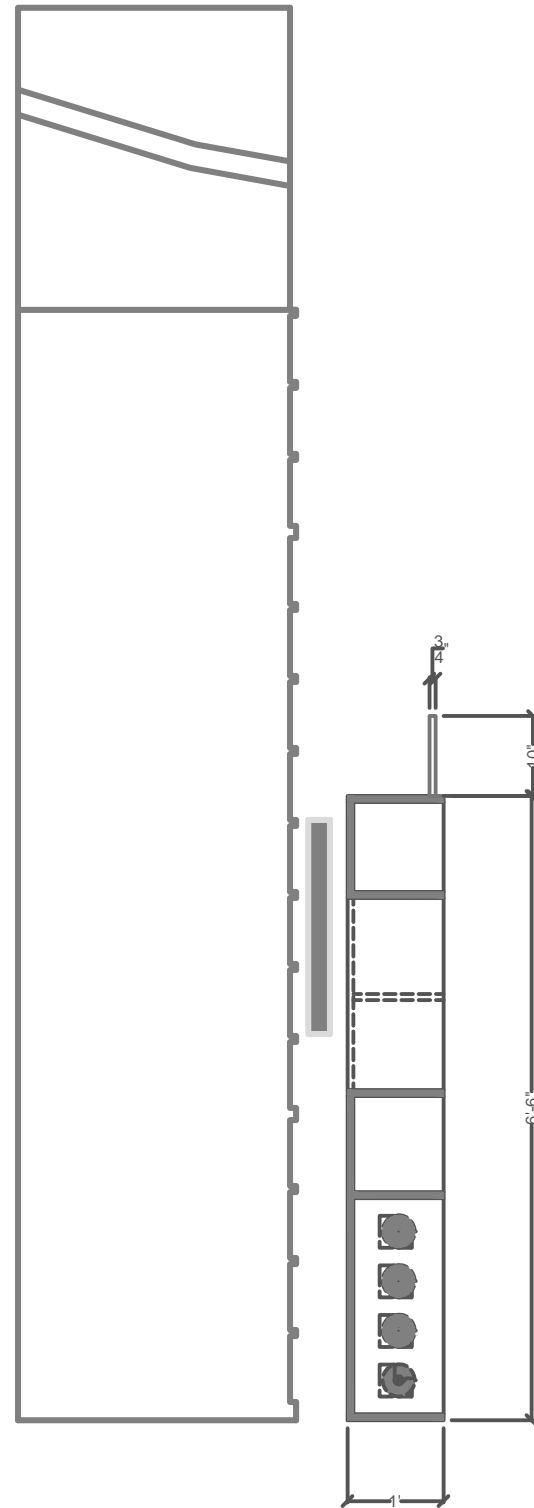

F3 SL PRO GIFT WRAP SHELF:
SIDE VIEW

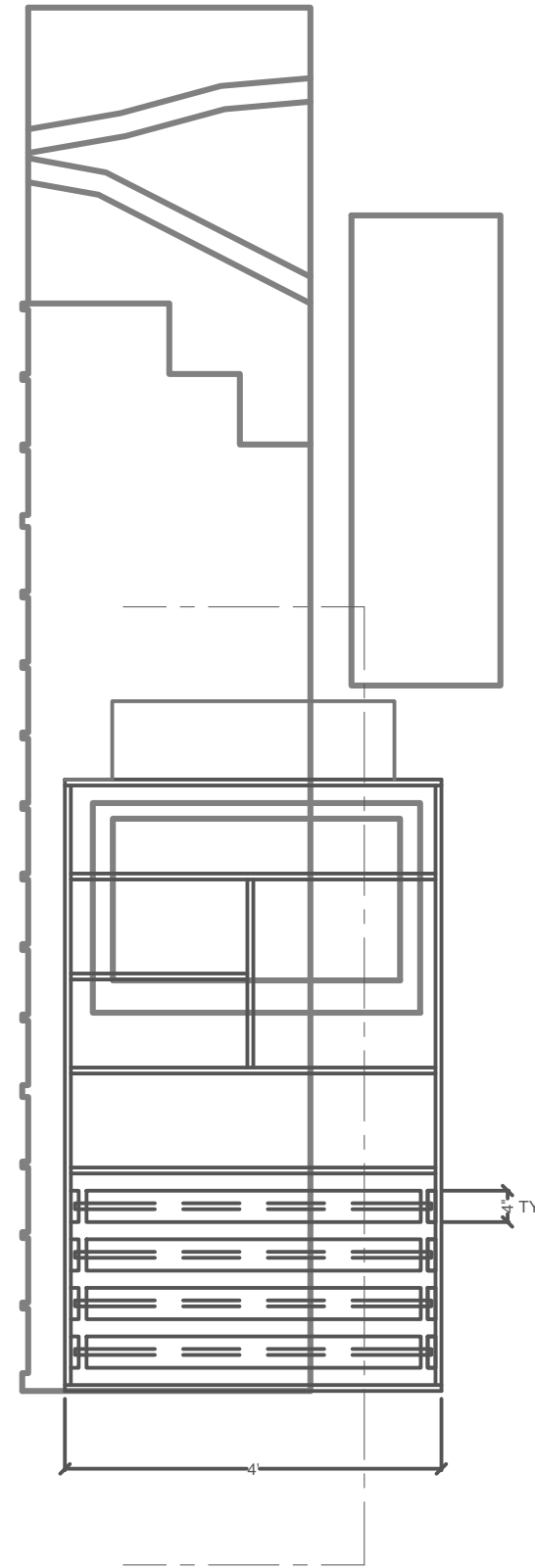

F2 SL PRO GIFT WRAP SHELF:
FRONT VIEW

Barter Theatre
Main Stage

Barter Players
2014 Holiday Show

Jingle All the Way

Drawing Date: 10.19.2014

Revision Date: 10.28.2014

Plot Date: n/a

Director: John Hardy

Tech Director: Caspar Eichen

Dwg By: HMB

Designer: Holly M Breuer

Drawing: SL Pro - Gift
Wrap Shelf

Plate Scale: 1/2" = 1'-0"

Plate
7 of 7